

HPLC

*Solvent
Delivery
Module
Systems*

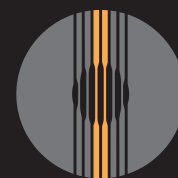

www.**GBC**sci.com
SCIENTIFIC EQUIPMENT

Who is GBC Scientific Equipment?

GBC Scientific Equipment was founded in 1978 and is now the world's third largest and fastest growing manufacturer of atomic absorption spectrometers with a sales and service network covering around 100 countries.



GBC's growth has been fuelled by its extensive AA expertise, innovative thinking and an obsession for quality and reliability. GBC now produces the widest range of AA spectrometers in the world, with options and accessories to suit every analytical requirement.

GBC supplies a wide range of HPLC equipment and applications information for almost every aspect of High Performance Liquid Chromatography, including:

- HPLC solvent delivery modules (isocratic, binary and quaternary)
- UV-Vis detectors (variable wavelength, dual wavelength, scanning)
- Fluorescence detector
- Conductivity detector
- Refractive Index detector
- Electrochemical detector
- Photo Diode array detector
- Auto injectors (pre-injection derivatization, small volume, variable volume capability)
- Data acquisition and management (Windows ®)
- Columns and accessories

ISO 9001 QUALITY ACCREDITATION

GBC has always placed a strong emphasis on quality in all aspects of our operation, from design and manufacture to the provision of service and support to our customers, and we are fully committed to continuous evaluation and improvement in all areas.

The GBC Quality Management System has been accredited to the ISO 9001 quality standard by Lloyd's Register Quality Assurance Limited. This certification is your assurance that the procedures and processes used to produce the goods and services which GBC provides comply with the relevant International Standard, and demonstrates our commitment to meeting the needs and expectations of our customers.



What is the GBC vision?

GBC Scientific Equipment

will

advance people's knowledge

and

their capacity to enhance the quality of life

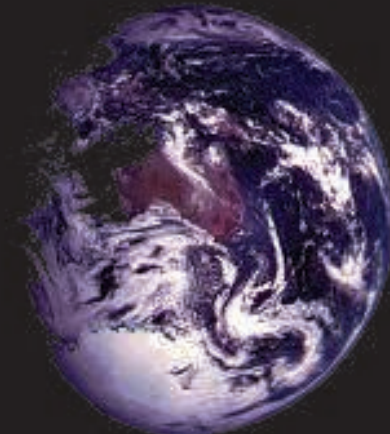

for all humankind.

GBC's product lines...



AAS



HPLC



ICP-OES



ICP-oTOFMS



Rheometer



UV-Vis



XRD

HPLC Solvent Delivery Modules

Challenging applications require flexibility and high performance

Rapidly changing requirements for analytical assays mean that today's isocratic applications may change into a complex gradient without discarding your existing equipment.

Method storage saves time and increases productivity

Stored methods, recalled with simple, easy-to-master function keys, save time and money with fast set-up and efficient routine system. Automatic start-up and shut-down methods ensure that your system is ready when you are, maximizing sample throughput and minimising equilibration time. This also saves solvent, reducing operational costs compared with other systems. With an integrated purge valve and one of the lowest dead volumes available, solvent changes are fast and easy.

Robust design for reliability

Leak sensors, bubble detectors, pressure limits, compressibility compensation and solvent level monitors, combined with only two check valves, provide assurance that your samples are running correctly, notifying you of occurrences which may jeopardize your results. Accessible external fluid path components and piston-seal wash facility make routine maintenance simple and easy. A built-in pump cycle counter keeps track of seal and check-valve wear so that preventative maintenance may be scheduled.

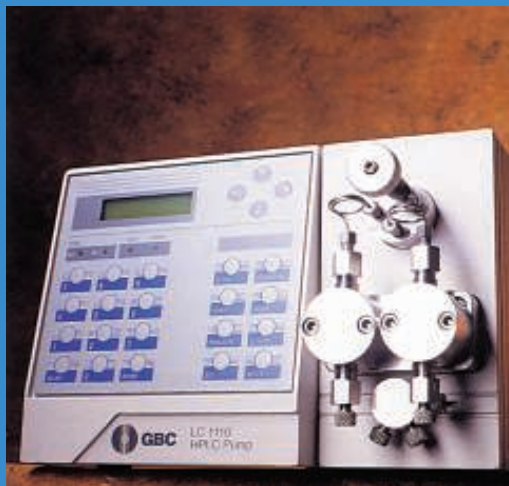

GBC 1100 Series Solvent Delivery Modules offer innovative and technologically advanced design available for any HPLC pumping system. With complete diagnostics and upgrade capabilities, analytical integrity is assured.



GBC 1100 Series Solvent Delivery Modules are designed specifically for the analyst. Free-floating dual in-series pistons, with variable volume delivery, guarantee reproducible flows with low piston-seal wear. This means accurate quantitative determinations.

Flexibility and High Performance

Optional features

Flow - the most important parameter

The essential task of an HPLC pump is to provide stable flow. Without it, other features are meaningless. High Performance Liquid Chromatography relies on precise, accurate flow for valid analytical results. Without stable flow, response from Refractive Index and Electrochemical detectors is questionable. Quantitation from all other detectors also suffers, particularly for sensitive analysis.

Most pumps utilize fixed-volume piston strokes to deliver the solvent. The majority of these pumps have 100 μl volumes per stroke at all possible flow rates. This results in dramatic pressure fluctuations and flow rate changes as the pistons cross over.

GBC pumps utilize a variable stroke mechanism, matching the flow rate with stroke column for minimal pressure fluctuations. The piston displacement carries between 16 and 100 μl .

Advanced engineering and extensive diagnostics mean dependable operation.

Your samples are the most valuable items in your laboratory. You cannot afford to waste them. With the GBC 1100 Series, all aspects of your analysis are continually monitored during operation. You are instantly notified of any deviation from set operational limits, or, during unattended operation, the details of the error are noted in the electronic log book to alert you when your return.

One pump for isocratic or quaternary capability

The LC1120 isocratic pump can be upgraded simply to binary or quaternary capability. The quaternary LC 1150 additionally provides the flexibility to store up to ten methods in memory, recall and execute them at the touch of a key, monitor the current method, or create a new method during an analytical run.

Precision gradients through engineering and research

The solvent proportioning valve is internally matched to each pump. This ensures the best compositional accuracy and precision, regardless of solvent selection. With a 700 μl dwell volume, our gradients are the sharpest available, and step gradients are as close as possible to ideal. The flow path is designed for maximum turbidity, allowing complete mixing in a very small volume, eliminating the need for an external mixer. Combining these features with a unique method of solvent proportioning, GBC has produced the finest quaternary gradient solvent delivery module available.

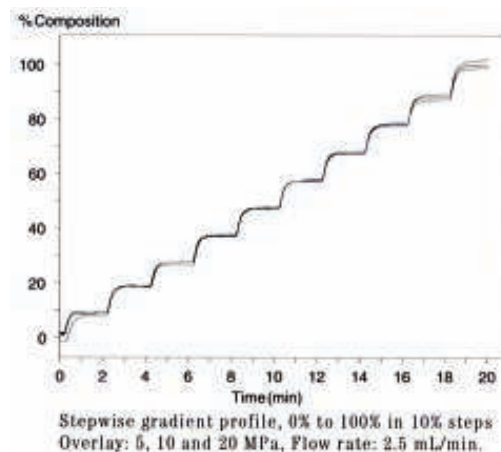

Reliability and Upgradability

Compositional accuracy

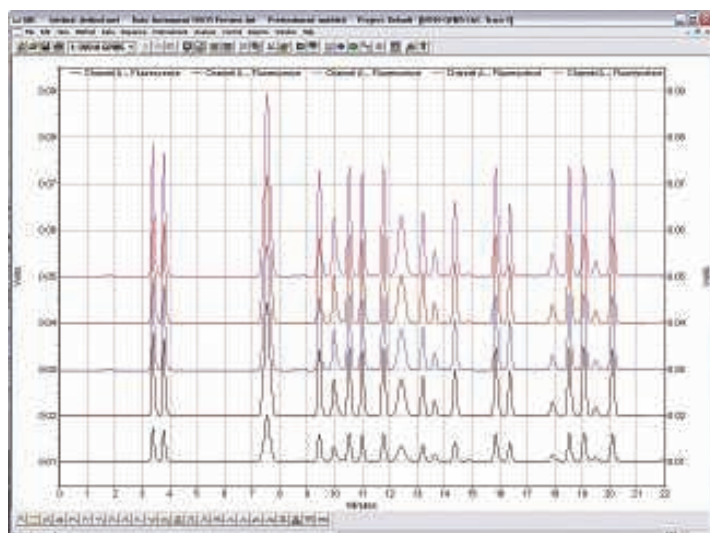
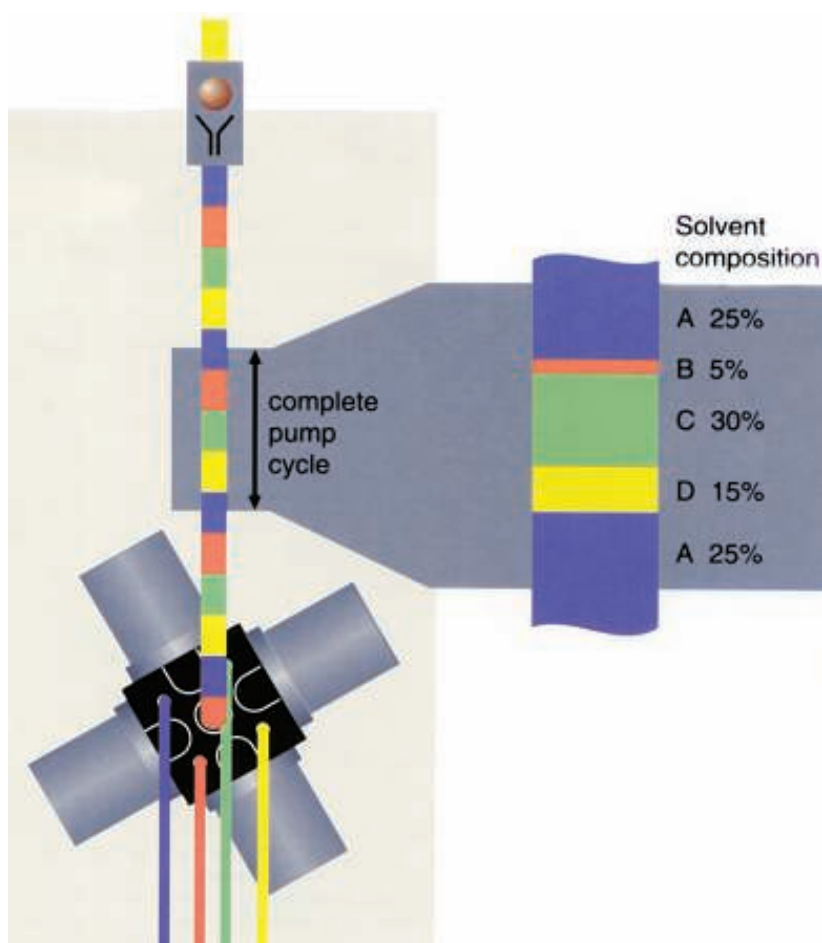

Connectivity and control

Interactive connection of the pump to the rest of the system prevents costly errors that may ruin valuable analyses. With two external events per method, and solvent level sensors which will shutdown the entire system when levels are too low to run all the samples, your valuable samples are preserved.

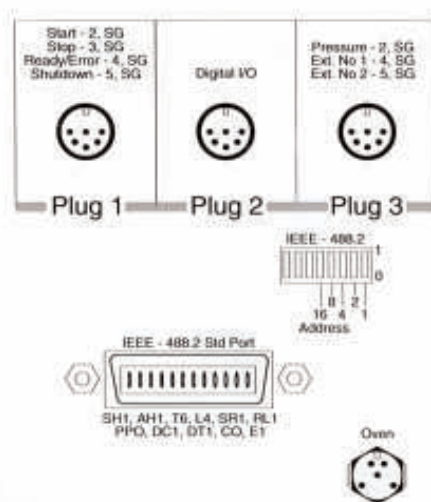

Compositional accuracy

The incorporation of the variable piston stroke mechanism enables a complete gradient to be delivered to the column in each pump cycle. For added accuracy, an automated algorithm splits the largest solvent component, sandwiching the smallest in the centre of the stroke.

Guaranteed Performance

Pump kits

LC 1150 Pump Kit

The GBC LC 1150 Pump kit combines the high performance LC1150 Quaternary Gradient HPLC Pump, LC 1460 On-Line Degasser and LC1445 System Organiser in a single kit. This kit is a complete and cost-effective solution to solvent delivery requirements in both gradient and solvent blending isocratic applications. It comes complete with solvent bottles, tubes and fittings for immediate operation.

THE GBC solvent delivery systems will improve the productivity and profitability of your laboratory because.....

- quaternary solvent delivery system provides maximum flexibility in method development and routine usage.
- tiny 700 μ L dwell volume provides for sharp gradients and eliminates the need for a separate mixer.
- dual piston design with two check valves ensures increased reliability, and superior flow characteristics with minimum pressure fluctuations.
- variable stroke hydraulic system maximizes flow stability.
- free-floating pistons with seal wash minimise seal and piston wear for maximum up-time.
- comprehensive diagnostics help to schedule preventative maintenance and maximize up-time.
- logical key pad functions are easy to use for rapid start-up and operation
- auto start-up and shut-down methods maximize the time available for analysis by performing equilibration runs before the day begins or after the day ends.
- solvent level monitoring prevents the unnecessary waste of samples.
- upgrade path for isocratic LC1120 provides low-cost entrance with expandable options without the necessity of retraining for new components and software.
- External event triggers for other chromatography modules.



LC1150 pump kit, including degasser and solvent organiser



HPLC equipment includes:

HPLC solvent delivery modules (isocratic, binary and quaternary)

UV-Vis detectors (variable wavelength, dual wavelength, scanning.)

Fluorescence detector
Conductivity detector
Refractive Index detector
Electrochemical detector
Photo Diode Array detector
Auto-injectors (pre-injection derivation, small volume, variable volume capability)
Data acquisition and management (Windows ®)
Columns and accessories

Improve Productivity

GBC HPLC Specifications

Hydraulic System

Dual in-series floating pistons driven by variable stroke mechanism with piston displacement from 16 - 100 μ l.

Flow Rate Range

0-9.99 mL/min, in 0.01 mL/min increments

Flow Rate Precision

0.1% independent of system pressure

Solvent Selection (LC1150)

Up to 4 solvents may be selected and mixed.

Composition Range (LC1150)

0-100% in 0.1% increments

Composition Accuracy (LC1150)

0.5% independent of system pressure

Composition Precision (LC1150)

0.1% RSD, binary gradient water/acetonitrile

Delay Volume (Dwell Volume)

600-900 μ l, dependent on system pressure

Compressibility Compensation

User-programmable compensation for changes in flow rate at varying system pressures and solvent compositions.

Pressure Pulsations

Typically 1.0% of system pressure at all pressures up to 10 MPa.

Pressure Range

Operating pressure range from 0-40MPa (6000 psi) to 5ml/min, from 0-20 MPa (3000 psi) for flow rates >5mL/min. Real time display in MPa or psi.

Method Storage (LC1150)

10 methods, each with up to twenty steps (160 steps max) stored in battery-backed RAM. Method editing is possible during a run.

Display

2 line x 16 character illuminate LCD with real-time display of operating parameters and status. Integrated keyboard. Numeric, cursor and function keys. Parameter editing possible during a run.

Analogue Output

25mV/MPa for pressure monitoring.

Remote Control

Output: Ready/error. Input: Remote shutdown, Start, Stop.

Remove Communications

Standard IEEE-488.2 communications.

Diagnostics and Safety Aids

Detected errors stored in the error log and displayed via the front panel LEDs, with audible alarm and/or interactive error message. Diagnostics include start-up testing, solvent leak and level detection, system pressure monitor, min/max pressure, bubble detection, pump cycles, equilibration monitor, pressure trace. Safety aids include programmable flow ramp rate and pump purge monitor to protect columns.

Operating Environment

4 to 40°C, < 85% relative humidity (non-condensing)

Power Requirements

100-120/220-240V, 50-60Hz

Dimensions

263 x 183 x 450 mm (W x H X D)

Weight

Nett 16.4 kg, Shipping 20 kg

LC 1460 On-Line Degasser

Type

Vacuum filtration, four channels

Degassing Efficiency

<2ppm at 3 ml/min (water at 25°C)

Internal Volume

<7 mL (per channel)

Wetted Flow

PEEK, PTFE

Maximum Flow

10 mL/min

Outputs

Two signals on error condition for shut-down of connected devices

Maintenance

Self cleaning vacuum system

Dimensions

72 x 135 x 310 mm (WxHxD)

Column Oven (Optional)

Temperature Range and Stability

(Ambient + 5)°C to (Ambient + 50)°C \pm 0.1

Temperature Control

Proportional readout, °C or °F.

Column Capacity

2 columns, each 250 mm x 4.6 mm

Oven Dimension

46 x 56 x 300 mm (W x H X D)

Accuracy and Precision

Ordering Information :

100 - 112000 LC 1120 Advanced Spindle-Driven HPLC Pump
100 - 115000 LC 1150 Quarternary Gradient HPLC Pump
100 - 115502 LC 1150 Pump Kit consisting of:
1 x 100-115000 LC 1150 Quarternary Gradient HPLC Pump
1 x 100-146001 LC 1460 On-Line Degasser
1 x 99-0288-00 LC 1445 System Organiser
4 x 97-2057-00 Solvent Bottle and Cap (with tube fittings)

Options

100 - 015500 LC 1120/LC1150 Column Oven Option Kit
99-0330-00 TC 2000 Peltier HPLC Column Oven
100-146001 LC1460 On-Line Degasser
99-0288-00 LC1445 System Organiser
100-003000 LC1120 to LC1150 Upgrade Kit.

Designed and manufactured by
GBC Scientific Equipment Pty Ltd
A.C.N. 005 472 686

GBC reserves the right to
change specifications without prior
notice.

GBC publication number
01-0269-03
Nov 2004 Australia

GBC SCIENTIFIC EQUIPMENT

Manufacturer of world-class
scientific instruments and
accessories -
AA, HPLC, ICP-OES, ICP-oTOFMS,
Rheometry, UV-Vis and XRD

12 Monterey Road
Dandenong, Victoria 3175
Australia

Telephone 61 3 9213 3666
Facsimile 61 3 9213 3677
email gbc@gbcsci.com
URL www.gbcsci.com

All trade-marks and trade-names
are the property of their respective
owners.

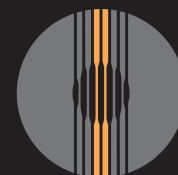

www.gbcsci.com
GBC SCIENTIFIC EQUIPMENT